

USER MANUAL FOR

MOTION CONTROLLERS

EXTENSION MODULE FOR MOOG RUGGEDIZED MOTION CONTROLLER (MSC-R-10)

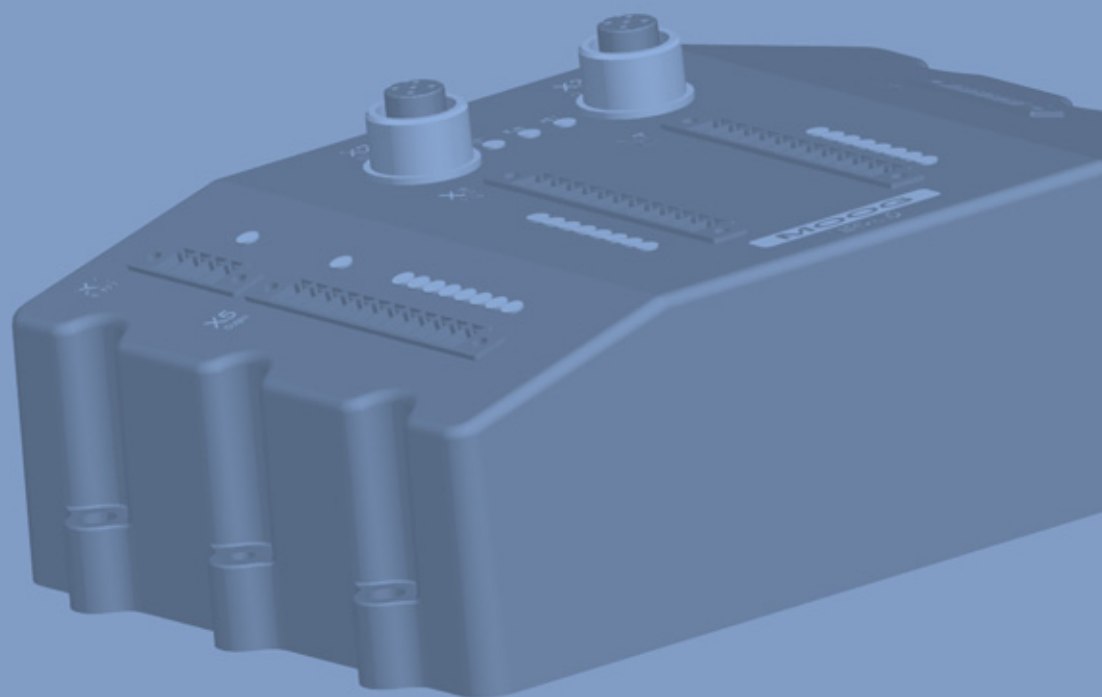

Rev. A, May 2014

EXTENSION MODULE WITH ETHERCAT
SLAVE INTERFACE FOR HARSH ENVIRONMENTS

Copyright

© 2014 Moog GmbH
Hanns-Klemm-Strasse 28
71034 Böblingen (Germany)
Telephone: +49 7031 622-0
Fax: +49 7031 622-100
E-Mail: Info.germany@moog.com
M3000-Support@moog.com
Internet: <http://www.moog.com/industrial>

All rights reserved.

Neither this manual nor parts of it may be reproduced in any form (print, photocopy, microfilm, or any other process) or processed, duplicated, or distributed through the use of electronic systems without Moog's written approval.

Offenders will be held liable for the payment of damages.

Subject to changes without prior notice.

 All M3000® modules comply with the standards specified in their relevant declaration of conformity. CE labeling of the M3000® modules is based on proper installation of the automation system with proven electromagnetic compatibility (EMC).

Table of Contents

List of Tablesiv

List of Figuresv

1 General Information 1

1.1 About this Manual 1

 1.1.1 Reservation of Changes and Validity 1

 1.1.2 Exclusion of Liability 1

 1.1.3 Completeness 1

 1.1.4 Place of Storage..... 1

1.2 Selection and Qualification of Personnel..... 2

1.3 Proper Use 2

 1.3.1 Safety Related Systems 2

1.4 Warranty and Liability 3

1.5 Inspection of Delivery 3

1.6 Environmental Protection 4

 1.6.1 Emissions 4

 1.6.2 Disposal..... 4

1.7 Standards 4

 1.7.1 CE Labeling of M3000® Modules 4

 1.7.2 IEC 61131-2 4

 1.7.3 Electromagnetic Compatibility (EMC)..... 4

1.8 Trademarks 5

1.9 Software Copyrights 5

2 Safety Instructions 6

2.1 Typographical Conventions 6

2.2 Safety Instructions 6

 2.2.1 Safety Related Systems 6

 2.2.2 Environmental Conditions 7

 2.2.3 ESD 7

 2.2.4 Project Planning and Installation 8

 2.2.5 Shutdown and Service 9

 2.2.6 Transportation and Storage..... 10

3 Environmental Conditions 11

3.1 Requirements of IEC 61131-2 11

3.2 Use in Special Environments 12

4 Mechanical Installation 13

4.1 Mounting 13

4.2 Removing 13

5 Project Planning and Installation	14
5.1 Grounding Concept.....	15
5.1.1 Front Panel Connectors' Grounding.....	15
5.2 Power Supply.....	16
5.2.1 Power Supply Characteristics	16
5.2.2 Connecting the Power Supply	17
5.2.3 Connecting Sensors	18
5.3 Connecting Signal Cables	19
5.3.1 Plug-In Terminal Strips.....	19
6 Shutdown and Service.....	20
6.1 Shutdown	20
6.2 Service.....	21
6.2.1 Maintenance/Serviceing	21
6.2.2 Repair.....	21
7 Transportation and Storage	22
7.1 Environmental Conditions.....	22
8 MSC-R-IO	23
8.1 Performance Characteristics.....	23
8.1.1 Interfaces.....	23
8.1.2 I/Os (Inputs/Outputs)	23
8.2 General Specifications.....	23
8.2.1 View of the Module.....	23
8.2.2 Dimensions.....	24
8.2.3 Mechanical Mounting	25
8.2.4 Environmental Conditions	26
8.3 Block Diagram	27
8.4 View of the Module and Terminal Assignment.....	28
8.4.1 Terminal Assignment.....	29
8.4.2 LEDs.....	32
8.4.3 EtherCAT Slave Interface.....	32
8.5 Power Supply.....	34
8.6 Digital I/Os.....	35
8.6.1 Status Display of Digital I/Os.....	35
8.6.2 Power Supply of the Digital I/Os.....	35
8.6.3 Digital Outputs.....	36
8.6.4 Digital Inputs.....	38
8.7 Temperature Sensor Input.....	40
8.7.1 PT Connection Diagram.....	41
8.8 EtherCAT Interface	42
8.9 Nameplate	42
9 Product Range.....	43
9.1 DIN Rail Mounting Kit for the MSC-R-IO	43
9.2 Plug-In Terminal Strips	43

10 Appendix.....44

- 10.1 Typographical Conventions 44**
- 10.2 Abbreviations..... 45**
- 10.3 Quoted Standards 47**
 - 10.3.1 CiA DS..... 47
 - 10.3.2 DIN 47
 - 10.3.3 EN 47
 - 10.3.4 IEC 48
 - 10.3.5 ISO/DIS 48
 - 10.3.6 TIA/EIA..... 49

11 Index.....50

List of Tables

Table 1: Power Supply Conditions of the Module's Internal Electronics and the Sensors 18

Table 2: Dimensions of the MSC-R-IO 24

Table 3: Terminal Assignment of MSC-R-IO's Connectors 29

Table 4: LEDs of the MSC-R-IO 32

Table 5: Pin assignment of M12 EtherCAT connectors..... 32

Table 6: Receive PDO 1 33

Table 7: Transmit PDO 1 33

Table 8: Transmit PDO 2 33

Table 9: Transmit PDO 3 33

Table 10: U/I Working Ranges of MSC-R-IO's Digital Inputs (Current Consuming)..... 40

Table 11: Product Range – DIN Rail Mounting Kit for the MSC-R-IO 43

Table 12: Product Range – Plug-In Terminal Strips 43

Table 13: Abbreviations 45

List of Figures

Figure 1: Grounding Concept 15

Figure 2: Moog Global Support..... 21

Figure 3: Front view of MSC-R-IO 23

Figure 4: Dimensions of the MSC-R-IO 24

Figure 5: MSC-R DIN Rail Mounting Kit 25

Figure 6: Block Diagram of the MSC-R-IO 27

Figure 7: View of the MSC-R-IO and Terminal Assignment 28

Figure 8: Basic Wiring Diagram of a Digital Output of the MSC-R-IO 36

Figure 9: Basic Wiring Diagram of a Digital Input of the MSC-R-IO (Current Consuming)..... 38

Figure 10: U/I Working Ranges of MSC-R-IO's Digital Inputs (Current Consuming)..... 40

Figure 11: PT connection diagram..... 41

Figure 12: Position of the Nameplate on the MSC-R-IO..... 42

1 General Information

1.1 About this Manual

This manual is valid only for the M3000[®] automation system and M3000[®] modules. It contains most important instructions that must be observed in order to operate the M3000[®] automation system and M3000[®] modules in a safe manner.

Every person responsible for machinery planning, mounting, and operation must read, understand, and follow all points covered in this manual. This applies especially to the safety instructions. Following the safety instructions helps to avoid accidents, faults, and material damage!

The following items must be observed as fundamental elements of safety when using the M3000[®] automation system and M3000[®] modules:

- All safety instructions contained in this manual
- All safety instructions contained in the documentation of the M3000[®] modules
- All safety instructions contained in the product related hardware and software documentation required for the relevant application
- All relevant nationally and internationally applicable safety and accident prevention regulations and standards

1.1.1 Reservation of Changes and Validity

The information contained in this manual is valid at the time of this version's release. See footer for version number and release date of this manual. Moog reserves the right to make changes to this manual at any time without specified reasons.

1.1.2 Exclusion of Liability

This manual was prepared with great care and the contents reflect the authors' best knowledge. However, the possibility of error remains and improvements are possible.

Please feel free to submit any comments regarding errors or incomplete information to Moog.

Moog does not offer any guarantee that the contents conform to applicable legal regulations nor does Moog accept any liability for incorrect or incomplete information and the consequences thereof.

1.1.3 Completeness

This manual is complete only when used in conjunction with the product related hardware and software documentation required for the relevant application.

1.1.4 Place of Storage

This manual and all other associated documentation for hardware and software must always be kept in a location where they will be readily accessible and close to the M3000[®] automation system and M3000[®] modules or the equipment in which they are installed.

About this Manual

Using M3000[®] Safely (Prerequisites)

Reservation of Changes and Validity for this Manual

Exclusion of Liability for this Manual

Completeness of this Manual

Place of Storage for this Manual

1.2 Selection and Qualification of Personnel

Only qualified users may work with and on the M3000[®] automation system or M3000[®] modules.

Qualified users are properly trained experts with the required knowledge and experience. In particular, these experts must have the authorization to bring into operation, ground, and label devices, systems, and power circuits in accordance with safety engineering standards. Those people working on a project must be familiar with safety concepts common in automation.

Qualified Users

1.3 Proper Use

The M3000[®] modular automation system is suitable for control applications in the medium to high end performance ranges.

M3000[®] is designed for use within the overvoltage category defined by IEC 60364-4-44 for controlling machines and industrial processes in low voltage systems in which the rated supply voltage does not exceed 1,000 V alternating current (50/60 Hz) or 1,500 V direct current.

Qualified project planning and design, proper transportation, storage, installation, and use are required to ensure fault-free, reliable, and safe operation of M3000[®].

M3000[®] and M3000[®] modules must not be brought into operation until it has been ensured that the equipment in which they are installed complies with the current version of the EU machinery directive.

The M3000[®] automation system and M3000[®] modules may be used only under the conditions and situations specified in this manual and in the documentation of the M3000[®] modules.

Any other or more extensive use is not permissible.

The following is also required for proper use:

- Compliance with the requirements detailed in this manual
- Compliance with the requirements of individual M3000[®] module documentation
- Compliance with all of the product related hardware and software documentation required for the relevant application
- Compliance with the relevant nationally and internationally applicable regulations, standards, and directives, e.g., the regulations specified by a professional organization, such as TÜV or VDE

Proper Use

1.3.1 Safety Related Systems

WARNING



As with any electronic automation system, the failure of certain components when using M3000[®] or M3000[®] modules might lead to an uncontrolled and/or unpredictable operational condition. The user should take into consideration the system level effects of all types of failures and implement corresponding safety measures.

Safety Related Systems

Special measures are required to use control technology in safety related systems.

When planning to use control technology in a safety related system, the user should seek detailed advice in addition to any available standards or guidelines for safety installations.

1.4 Warranty and Liability

Moog's standard delivery and payment conditions apply. The owner/operator will have access to these by the time the contract is closed at the latest.

Warranty and liability claims for personal and material damage will be excluded when they are the result of the following, among others:

- Improper use of the M3000[®] automation system or M3000[®] modules
⇒ "1.3 Proper Use" on page 2
- Use of the M3000[®] automation system or M3000[®] modules in a technically imperfect condition
- Use of the M3000[®] automation system or M3000[®] modules by unqualified users
⇒ "1.2 Selection and Qualification of Personnel" on page 2
- Failure to comply with this manual, the documentation of the M3000[®] modules, or the product related hardware and software documentation required for the relevant application
- Failure to comply with the relevant nationally and internationally applicable regulations such as the regulations of a professional association, the TÜV, or the VDE
- Improper deployment of the M3000[®] automation system or M3000[®] modules, such as in a potentially explosive, excessively warm, or excessively cold environment
- Improper storage, transportation, mounting, removing, connection, bringing into operation, operation, cleaning, or maintenance of the M3000[®] automation system or M3000[®] modules
- Storage or transportation of M3000[®] modules or accessories outside of the original packaging
⇒ "7 Transportation and Storage" on page 22
- Unauthorized or improperly executed structural changes to the M3000[®] automation system or M3000[®] modules
- Unauthorized or improperly executed repairs on the M3000[®] automation system or M3000[®] modules
⇒ "6.2.2 Repair" on page 21
- Damage due to the intrusion of foreign objects or acts of God.

Exclusion of Warranty and Liability

1.5 Inspection of Delivery

After receiving the delivery, please check the original packaging and its contents for any damage.

If the packaging or contents exhibit any damage, do not bring the items into operation. In this case, immediately notify Moog or the responsible supplier. In addition, the packaging should be retained. The packaging might be needed to enforce damage compensation claims on the transport company.

After taking the delivery, please check whether all items listed on the delivery docket are present. If anything is missing, immediately notify Moog or the responsible supplier.

It is advisable to retain the original packaging for any future transport or storage needs.

Inspection of Delivery

Retain the Original Packaging

1.6 Environmental Protection

1.6.1 Emissions

M3000[®] modules do not have any harmful emissions when used properly.

**Environmental Protection:
Emissions**

1.6.2 Disposal

 The applicable disposal regulations must be observed when disposing of M3000[®] modules!

**Environmental Protection:
Disposal**

1.7 Standards

1.7.1 CE Labeling of M3000[®] Modules



All M3000[®] modules comply with the standards specified in their relevant declaration of conformity. CE labeling of the M3000[®] modules is based on proper installation of the automation system with proven electromagnetic compatibility (EMC).

**CE Labeling of M3000[®]
Modules**

1.7.2 IEC 61131-2

The M3000[®] automation system and M3000[®] modules comply with the requirements of IEC 61131-2.

**M3000[®] and M3000[®]
Modules Comply with
IEC 61131-2**

 Where technical requirements lead to deviations from the standard, these are specified in this manual or in the documentation of the relevant M3000[®] modules.

1.7.3 Electromagnetic Compatibility (EMC)

M3000[®] modules comply with the requirements and protection targets of the EU directive 2004/108/EC "Electromagnetic Compatibility" (EMC directive) and comply with the harmonized European standards (EN) that were published in the Official Journals of the European Union for programmable controllers.

**Electromagnetic
Compatibility (EMC)**

Especially important are the rules for proper EMC wiring in cabinets and buildings according to IEC 61131-4. Installation in metal, grounded cabinets is preferred.

M3000[®] modules are designed for use under normal operating conditions in industrial environments and comply with the following standards:

- EN 61000-6-2
- EN 61000-6-4

If suitable additional measures are taken, M3000[®] modules may also be employed in residential, commercial and light-industrial environments in compliance with the following standards:

- EN 61000-6-1
- EN 61000-6-3

Suitable additional measures:

⇒ ["3.2 Use in Special Environments" on page 12](#)

If the system does not comply with the requirements of EN 61000-6-1 and EN 61000-6-3, despite the additional measures, M3000® modules must not be used in residential, commercial and light-industrial environments.

EMC conformity may be presumed only under the following conditions:

- Sufficient shielding

The MSC-R-IO must be powered from a power supply with SELV (Safety Extra-Low Voltage) according to EN 60950-1. Therefore the EU low voltage directive is not relevant for the M3000® automation system because the specified voltage levels are below the limits.

1.8 Trademarks

Moog and Moog Authentic Repair are registered trademarks of Moog Inc. and its subsidiaries.

EtherCAT® is registered trademark and patented technology licensed by Beckhoff Automation GmbH, Germany.

M3000® is a trademark of Moog GmbH that is registered in the EU.

-  All product and company names mentioned in this manual might be protected trademarks or brands of the relevant manufacturer.
The absence of the symbols ® or ™ does not indicate that the name is free from trademark protection.

Trademarks

1.9 Software Copyrights

The software that is installed on M3000® products at the time of delivery is the property of the manufacturer. At the time of delivery, every piece of installed software is covered by copyright protection. It may be reproduced only with the approval of the manufacturer or in accordance with the license agreements.

Software Copyrights

2 Safety Instructions

This chapter summarizes the most important safety instructions. When handling the M3000[®] automation system or M3000[®] modules the safety instructions in the other chapters of this manual must be followed as well as the safety instructions in the product related hardware and software documentation required for the specific application.

Following the safety instructions helps to avoid accidents, faults, and material damage!

2.1 Typographical Conventions

The following symbols and styles are used for identifying the different types of safety instructions:

**Safety Instructions:
Typographical
Conventions**

DANGER



Identifies safety instructions that are intended to warn of an immediate and impending danger to life and limb or major property damage.

Failure to observe these safety instructions will lead inevitably to death, serious personal injury (disablement) or major property damage!

WARNING



Identifies safety instructions that are intended to warn of potential danger to life and limb or the potential for major property damage.

Failure to observe these safety instructions might lead to death, serious personal injury (disablement) or major property damage!

CAUTION



Identifies safety instructions that are intended to warn of slight personal injury or minor property damage.

Failure to observe these safety instructions might lead to slight personal injury or minor property damage.

Additional typographical conventions:

⇒ ["10.1 Typographical Conventions" on page 44](#)

2.2 Safety Instructions

2.2.1 Safety Related Systems

WARNING



As with any electronic automation system, the failure of certain components when using M3000[®] or M3000[®] modules might lead to an uncontrolled and/or unpredictable operational condition. The user should take into consideration the system level effects of all types of failures and implement corresponding safety measures.

**Safety Instructions: Safety
Related Systems**

More on this subject: ⇒ ["1.3.1 Safety Related Systems" on page 2](#)

2.2.2 Environmental Conditions

WARNING

Maintain under all circumstances the required environmental conditions specified for the M3000[®] automation system or M3000[®] modules.

This ensures fault-free, reliable, and safe operation.

**Safety Instructions:
Environmental Conditions**

WARNING

The PC on which tools such as MACS development environment are installed must be suitable for the environmental conditions in which it will operate.

This ensures fault-free, reliable, and safe operation.

WARNING

It is not permissible to operate the M3000[®] automation system or M3000[®] modules in a potentially explosive environment.

WARNING

The M3000[®] automation system and M3000[®] modules must not come into direct contact with liquids, except where explicitly specified. Danger of short-circuit!

If they do come into direct contact with a liquid, immediately disconnect the power supply! Before bringing the system back into operation, it is essential that all affected components are completely dry and have been inspected by a suitably qualified technician.

More on this subject:

⇒ ["3 Environmental Conditions" on page 11](#)

⇒ ["8.2.4 Environmental Conditions" on page 26](#)

2.2.3 ESD

WARNING

Protect the M3000[®] automation system, M3000[®] modules, and the license key from electrostatic discharges!

Electrostatic discharges might damage the device's internal components or delete the device's internal memory.

Safety Instructions: ESD

2.2.4 Project Planning and Installation

WARNING

The vent holes of M3000[®] modules facilitate convection cooling and must never be covered! Covered vent holes might result in overheating and fire.

**Safety Instructions:
Project Planning and
Installation**

WARNING

No work of any kind, such as mounting, removing, wiring, or repairs to the M3000[®] modules may be performed while the modules are in operation!

There is a danger of:

- Uncontrolled movements
- Permanent damage
- Malfunctions

Before performing any work on M3000[®] modules, it is essential that the system is stopped and the power supply is disconnected.

Therefore, all power supplies must be switched off, including those from attached peripherals such as externally supplied transmitters, programming devices, etc.!

WARNING

M3000[®] modules must be protected from overvoltages and/or reverse energization from the sensor to the module!

There is a danger of:

- Permanent damage by overheating or fire
- Malfunctions

M3000[®] modules must have the correct voltage, polarity, and terminal assignments.

WARNING

The internal electronics of M3000[®] modules and attached sensors must be supplied with power from a permanently connected (unswitched) power supply that cannot be individually switched off, without switching off the module's power supply.

If a switched power supply is used, such as when there are intermediate switching devices (emergency stops, manual operators, etc.), the following problems might arise, depending on the state of the power supply for the internal electronics of the module and sensors ([⇒ table 1 on page 18](#)):

- Invalid sensor data

WARNING

Sensors that are connected to digital inputs of M3000[®] modules with several I/O groups, such as MSC I, QDIO, or RDIO, must always be supplied from the same power supply as the corresponding I/O group to which the sensor is connected!

Otherwise, if the power supply for the internal electronics of the module is switched off, there might be reverse energization from the sensor to the module.

There is a danger of:

- Uncontrolled movements
- Fault or failure of a manual control
- Permanent damage to the module
- Malfunctions

Digital I/Os of MSC II, MSC-R-IO and MSD Motion Controller are protected against reverse energization.

More on these subjects:

⇒ ["4 Mechanical Installation" on page 13](#) or

⇒ ["5 Project Planning and Installation" on page 14](#)

2.2.5 Shutdown and Service

WARNING

To avoid damage to M3000[®] modules or accessories, cleaning, maintenance, and repair tasks may be performed only by Moog or Moog's authorized service agents.

Warranty and liability claims for personal and material damage are excluded when, among other reasons, they are due to unauthorized repairs or other unauthorized interventions.

⇒ ["1.4 Warranty and Liability" on page 3](#)

**Safety Instructions:
Shutdown and Service**

WARNING

No work of any kind, such as mounting, removing, wiring, or repairs to the M3000[®] modules may be performed while the modules are in operation!

There is a danger of:

- Uncontrolled movements
- Permanent damage
- Malfunctions

Before performing any work on M3000[®] modules, it is essential that the system is stopped and the power supply is disconnected.

Therefore, all power supplies must be switched off, including those from attached peripherals such as externally supplied transmitters, programming devices, etc.!

WARNING

The M3000[®] automation system and M3000[®] modules must not come into direct contact with liquids, except where explicitly specified. Danger of short-circuit!

If they do come into direct contact with a liquid, immediately disconnect the power supply! Before bringing the system back into operation, it is essential that all affected components are completely dry and have been inspected by a suitably qualified technician.

WARNING

If an M3000[®] module is to be taken out of operation, the entire system must always be shut down and disconnected from all power supplies.

Therefore, all power supplies must be switched off, including those from attached peripherals such as externally supplied transmitters, programming devices, etc.! The M3000[®] module must be protected against unintentional restarting!

If the M3000[®] module is connected to other devices and/or facilities, always consider the full consequences and take appropriate precautions before switching off the module.

More on these subjects: ⇒ ["6 Shutdown and Service" on page 20](#)

2.2.6 Transportation and Storage

WARNING

Maintain, under all circumstances, the required environmental conditions specified for transportation and storage of the M3000[®] automation system or M3000[®] modules.

⇒ ["7.1 Environmental Conditions" on page 22](#)

This ensures fault-free, reliable, and safe operation.

**Safety Instructions:
Transportation
and Storage**

More on this subject: ⇒ ["7 Transportation and Storage" on page 22](#)

3 Environmental Conditions

WARNING

Maintain under all circumstances the required environmental conditions specified for the M3000[®] automation system or M3000[®] modules.

This ensures fault-free, reliable, and safe operation.

**Environmental
Conditions:
Safety Instructions**

WARNING

It is not permissible to operate the M3000[®] automation system or M3000[®] modules in a potentially explosive environment.

WARNING

The M3000[®] automation system and M3000[®] modules must not come into direct contact with liquids, except where explicitly specified. Danger of short-circuit!

If they do come into direct contact with a liquid, immediately disconnect the power supply! Before bringing the system back into operation, it is essential that all affected components are completely dry and have been inspected by a suitably qualified technician.

3.1 Requirements of IEC 61131-2

The M3000[®] automation system and M3000[®] modules comply with the requirements of IEC 61131-2.

-  Where technical requirements lead to deviations from the standard, these are specified in this manual or in the documentation of the relevant M3000[®] modules.

Environmental conditions for the MSC-R-IO:

⇒ ["8.2.4 Environmental Conditions" on page 26](#)

-  Refer to the relevant documentation for the specified environmental conditions for the other M3000[®] modules.

**Environmental
Conditions: Requirements
of IEC 61131-2**

3.2 Use in Special Environments

In the following cases, M3000® modules must **not** be used without taking additional measures, except where explicitly specified:

- At sites with difficult operating conditions, like those caused by
 - Aggressive vapors or gases
 - Corrosive atmospheres
 - Potentially explosive environments

In these cases, the suitable additional measures to be taken may include, for example, installation in specially designed cabinets.

- In systems that require special monitoring, such as:
 - Elevators
 - Electrical systems located in particularly (potentially) hazardous environments
 - In residential, commercial, and light-industrial environments
 - In medical environments

Examples of suitable additional measures in these cases may include:

- Installation in grounded, shielded metal cabinets
- Installation of filters in the power supply cables
- Use of shielded cables outside of cabinets

Limitations of Using M3000® Modules

4 Mechanical Installation

4.1 Mounting

WARNING

No work of any kind, such as mounting, removing, wiring, or repairs to the M3000[®] modules may be performed while the modules are in operation!

There is a danger of:

- Uncontrolled movements
- Permanent damage
- Malfunctions

Before performing any work on M3000[®] modules, it is essential that the system is stopped and the power supply is disconnected.

Therefore, all power supplies must be switched off, including those from attached peripherals such as externally supplied transmitters, programming devices, etc.!

Mounting:**Safety Instructions**

Information about mounting/removing the MSC-R-IO:

⇒ ["8.2.3 Mechanical Mounting" on page 25](#)

4.2 Removing

WARNING

No work of any kind, such as mounting, removing, wiring, or repairs to the M3000[®] modules may be performed while the modules are in operation!

There is a danger of:

- Uncontrolled movements
- Permanent damage
- Malfunctions

Before performing any work on M3000[®] modules, it is essential that the system is stopped and the power supply is disconnected.

Therefore, all power supplies must be switched off, including those from attached peripherals such as externally supplied transmitters, programming devices, etc.!

Removing:**Safety Instructions**

Information about mounting/removing the MSC-R-IO:

⇒ ["8.2.3 Mechanical Mounting" on page 25](#)

5 Project Planning and Installation

The following instructions must be observed in order to ensure that the M3000[®] automation system will be safely integrated into its application environment:

Project Planning and Installation

- **IEC 61131**
Especially the information contained in IEC 61131-4
- **Safety**
All safety and accident prevention regulations applicable to the specific application (such as machinery directives, safety instructions contained in documentation, etc.)
- **Emergency stop**
The emergency stop devices (EN 60204) must remain in effect during all of the system's or facility's operational modes.
- **Restarting**
Unlocking of the emergency stop devices must not lead to uncontrolled or undefined restarting.
Dangerous operational conditions of any kind must not arise following interruption or failure of the power supply.
- **Voltage**
Deviations and fluctuations of the supply and load voltages must not fall below or exceed the specified tolerances.
Deviations outside the specified operating range might lead to dangerous conditions and functional disturbances in the automation system.
- **Power supply 24 V DC**
M3000[®] modules must be supplied only with 24 V DC SELV (Safety Extra-Low Voltage) according to EN 60950-1.
⇒ ["5.2.1 Power Supply Characteristics" on page 16](#)
- **Wire fault**
A cable or wire fault must not lead to undefined conditions. All necessary safety precautions must be taken in the hardware and software.
- **Connection**
All connection and signal cables must be installed in such a way that inductive or capacitive interferences will not impair the M3000[®] automation system.

5.1 Grounding Concept

Grounding Concept

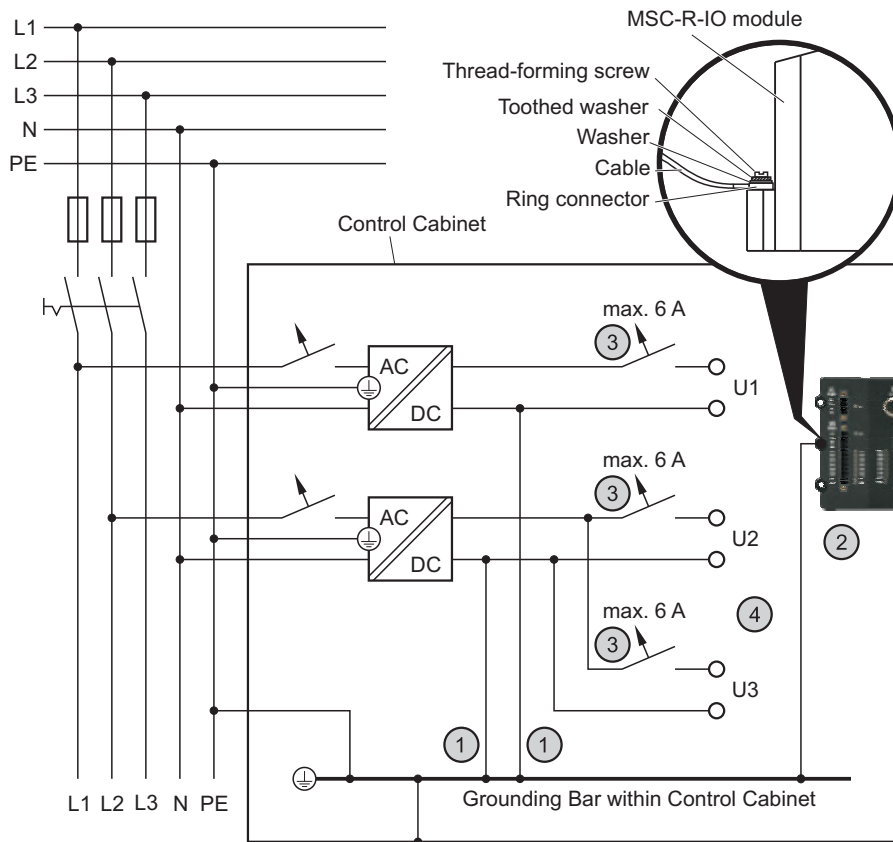

Figure 1: Grounding Concept

- ① For reasons of functional safety, all circuits must be grounded at a centralized point.
- ② The PE-conductor of the module must have a low resistance connection to the protective earth conductor (PE).
- ③ Every circuit must be fused.

If the output current of the power supply is greater than the maximum current of the connector, then the power cable to each M3000[®] module must be fused to the maximum current of the connector or a lower value or the current must be limited in another way.

Current limits of power connectors are:

- 12 A for MSC I, MSC II, E-Bus extension modules, MSD Motion Controller and DialogController displays
- 4 A for MSC-R
- 6 A for MSC-R-IO

- ④ Load-controlled distribution of the circuits (U1...U3)

5.1.1 Front Panel Connectors' Grounding

The metal housings of all front panel connectors of the MSC-R-IO are connected internally to the grounding of the housing.

Front Panel Connectors' Grounding

5.2 Power Supply

The internal electronics of M3000[®] modules is usually supplied with power via the power supply terminals of the connectors of the M3000[®] modules.

Connecting the power supply for the internal electronics:

⇒ "5.2.2 Connecting the Power Supply" on page 17

Power supply terminals of the MSC-R-IO:

⇒ "8.4.1 Terminal Assignment" on page 29

i Refer to the relevant documentation for the exact designations of the power supply terminals of the other M3000[®] modules.

Power Supply for M3000[®] Modules

5.2.1 Power Supply Characteristics

Output voltage

Rated voltage: 24 V DC, operates at no-load
SELV according to EN 60950-1
⇒ "5.2.1.1 Safety Extra-Low Voltage (SELV)"
on page 17

Run-up time (10 to 90 %): ≤ 0.2 sec.

i To ensure compatibility with other components, Moog recommends maintaining the power supply tolerance band specified in IEC 61131-2 (19.2 V to 30 V).

i Refer to the relevant documentation for the specified voltage ranges of the M3000[®] modules.

i Besides the specified voltage ranges, a total alternating voltage component with a peak value of 5 % of the rated voltage is also permitted.

Power Supply Characteristics of M3000[®] Modules

Output current

If the output current of the power supply is greater than the maximum current of the connector, then the power cable to each M3000[®] module must be fused to the maximum current of the connector or a lower value or the current must be limited in another way.

Current limits of power connectors are:

- 12 A for MSC I, MSC II, E-Bus extension modules, MSD Motion Controller and DialogController displays
- 4 A for MSC-R
- 6 A for MSC-R-IO

Maximum permissible duration of power interruptions

Under full load (severity class PS1 of voltage dips, according to IEC 61131-2): ≤ 1 ms

(duration of interruption during voltage drops and interruptions to the input voltage)

i During primary side voltage drops that are 1 ms or shorter in duration, the output voltage must not fall under 19.2 V when under full load. In addition, the interval between the primary side drops must not be shorter than 1 s.

5.2.1.1 Safety Extra-Low Voltage (SELV)

The safety extra-low voltage is a voltage that will not exceed 25 V AC or 60 V DC peak or direct voltage as measured between conductors or between a conductor and ground. The circuit in which SELV is used must be separated from the mains power supply by a safety transformer or something of equal functionality. Always observe national regulations when choosing the rated insulation voltage.

Safety Extra-Low Voltage (SELV)

5.2.2 Connecting the Power Supply

DANGER



The 24 V power supply terminals of all M3000[®] modules are protected against reverse polarity. If the polarity of these power supply terminals is reversed, the modules will not work.

Connecting the Power Supply: Safety Instructions

WARNING



No work of any kind, such as mounting, removing, wiring, or repairs to the M3000[®] modules may be performed while the modules are in operation!

There is a danger of:

- Uncontrolled movements
- Permanent damage
- Malfunctions

Before performing any work on M3000[®] modules, it is essential that the system is stopped and the power supply is disconnected.

Therefore, all power supplies must be switched off, including those from attached peripherals such as externally supplied transmitters, programming devices, etc.!

WARNING



M3000[®] modules must be protected from overvoltages and/or reverse energization from the sensor to the module!

There is a danger of:

- Permanent damage by overheating or fire
- Malfunctions

M3000[®] modules must have the correct voltage, polarity, and terminal assignments.

WARNING



The internal electronics of M3000[®] modules and attached sensors must be supplied with power from a permanently connected (unswitched) power supply that cannot be individually switched off, without switching off the module's power supply.

If a switched power supply is used, such as when there are intermediate switching devices (emergency stops, manual operators, etc.), the following problems might arise, depending on the state of the power supply for the internal electronics of the module and sensors ([⇨ table 1 on page 18](#)):

- Invalid sensor data

	Power Supply	
	Internal Electronics	Sensors
Module and sensors are in operation	on	on
Reverse energization from sensor to module	off	on
Invalid sensor data	on	off
Module and sensors are not in operation	off	off

Table 1: Power Supply Conditions of the Module's Internal Electronics and the Sensors

Power Supply for the Module's Internal Electronics and the Sensors

Power supply terminals of the MSC-R-IO:
⇒ "8.4.1 Terminal Assignment" on page 29

- ❗ Refer to the relevant documentation for information about the power supply terminals of the other M3000® modules.
- ❗ Internal module capacities might cause power spikes of up to 50 A when switching on the power supply for the internal electronics of the M3000® module. The duration of these spikes is strongly dependent on the internal resistance of the power supply.

5.2.2.1 Maximum Admissible Current

All power supply terminals of MSC-R-IO and the associated internal connections are designed for a maximum current of 6 A.

Maximum Admissible Current for MSC-R-IO

If the output current of the power supply is greater than the maximum current of the connector, then following must be employed:

- Several separately fused circuits or
- Several separate power supplies in separated circuits

5.2.3 Connecting Sensors

WARNING



The internal electronics of M3000® modules and attached sensors must be supplied with power from a permanently connected (unswitched) power supply that cannot be individually switched off, without switching off the module's power supply.

Connecting Sensors: Safety Instructions

If a switched power supply is used, such as when there are intermediate switching devices (emergency stops, manual operators, etc.), the following problems might arise, depending on the state of the power supply for the internal electronics of the module and sensors (⇒ table 1 on page 18):

- Invalid sensor data

5.3 Connecting Signal Cables

WARNING

No work of any kind, such as mounting, removing, wiring, or repairs to the M3000[®] modules may be performed while the modules are in operation!

There is a danger of:

- Uncontrolled movements
- Permanent damage
- Malfunctions

Before performing any work on M3000[®] modules, it is essential that the system is stopped and the power supply is disconnected.

Therefore, all power supplies must be switched off, including those from attached peripherals such as externally supplied transmitters, programming devices, etc.!

⇒ "8.4.1 Terminal Assignment" on page 29

5.3.1 Plug-In Terminal Strips

Plug-in terminal strips for the following methods are available from Moog:

- Screw terminals
- Spring loaded terminals

⇒ "9.2 Plug-In Terminal Strips" on page 43

5.3.1.1 Spring Loaded Terminals

CAUTION

When connecting a wire, insert the screwdriver only into the rectangular opening of the spring loaded terminal. If a screwdriver is inserted into the round opening for the wire, the spring loaded terminal might be destroyed. Spring loaded terminals make it easy to rapidly connect supply and signal cables.

Procedure for connecting a wire:

1. Insert the tip of a screwdriver into the rectangular opening of the spring loaded terminal and press the screwdriver downward.
2. Insert the wire into the corresponding round opening.
3. Remove the screwdriver from the opening.
The spring will hold the wire in place.

**Connecting Signal Cables:
Safety Instructions**

**Connection Methods for
Plug-In Terminal Strips
of M3000[®] Modules**

Spring Loaded Terminals

6 Shutdown and Service

WARNING

To avoid damage to M3000[®] modules or accessories, cleaning, maintenance, and repair tasks may be performed only by Moog or Moog's authorized service agents.

Warranty and liability claims for personal and material damage are excluded when, among other reasons, they are due to unauthorized repairs or other unauthorized interventions.

⇒ "1.4 Warranty and Liability" on page 3

Shutdown and Service:
Safety Instructions

WARNING

No work of any kind, such as mounting, removing, wiring, or repairs to the M3000[®] modules may be performed while the modules are in operation!

There is a danger of:

- Uncontrolled movements
- Permanent damage
- Malfunctions

Before performing any work on M3000[®] modules, it is essential that the system is stopped and the power supply is disconnected.

Therefore, all power supplies must be switched off, including those from attached peripherals such as externally supplied transmitters, programming devices, etc.!

WARNING

The M3000[®] automation system and M3000[®] modules must not come into direct contact with liquids, except where explicitly specified. Danger of short-circuit!

If they do come into direct contact with a liquid, immediately disconnect the power supply! Before bringing the system back into operation, it is essential that all affected components are completely dry and have been inspected by a suitably qualified technician.

6.1 Shutdown

WARNING

If an M3000[®] module is to be taken out of operation, the entire system must always be shut down and disconnected from all power supplies.

Therefore, all power supplies must be switched off, including those from attached peripherals such as externally supplied transmitters, programming devices, etc.! The M3000[®] module must be protected against unintentional restarting!

If the M3000[®] module is connected to other devices and/or facilities, always consider the full consequences and take appropriate precautions before switching off the module.

Shutdown:
Safety Instructions

6.2 Service

WARNING



To avoid damage to M3000[®] modules or accessories, cleaning, maintenance, and repair tasks may be performed only by Moog or Moog's authorized service agents.

Warranty and liability claims for personal and material damage are excluded when, among other reasons, they are due to unauthorized repairs or other unauthorized interventions.

⇒ "1.4 Warranty and Liability" on page 3

CAUTION



To avoid damage to the internal components, never attempt to open M3000[®] modules!

**Maintenance/Repair:
Safety Instructions**

6.2.1 Maintenance/Service

M3000[®] modules are maintenance-free. They do not contain any components (such as batteries) that must be maintained or replaced.

Maintenance/Service

6.2.2 Repair

Only Moog and Moog's authorized service agents can access the required and most up-to-date specifications. These specifications make it possible to restore the M3000[®] modules' original performance and ensure the same high reliability and long service life of the M3000[®] modules after repairs are completed.

Repair

Moog Global Support



Figure 2: Moog Global Support

Moog's Global Support Logo indicates that a Moog repair has been carried out.

- ① If Moog receives a repair order for defective M3000[®] modules, Moog and Moog's authorized service agents reserve the right to repair the defective module or, alternatively, to replace the defective module with a module of identical or compatible specifications.
- ① If Moog receives a repair order for defective M3000[®] modules, Moog and Moog's authorized service agents accept no liability for software and data installed by the customer.
- ① Please note: As the MSC-R-IO is sealed, it is not possible to repair the module.

7 Transportation and Storage

WARNING



Maintain, under all circumstances, the required environmental conditions specified for transportation and storage of the M3000[®] automation system or M3000[®] modules.

⇒ ["7.1 Environmental Conditions" on page 22](#)

This ensures fault-free, reliable, and safe operation.

**Transportation
and Storage:
Safety Instructions**

CAUTION



To avoid condensation, do not start M3000[®] modules until they have reached ambient temperature (except MSC-R and MSC-R-IO).

CAUTION



To avoid damage, M3000[®] modules and accessories must be transported and stored in their original packaging.

Warranty and liability claims for personal or material damage will be excluded when they are the result of, among other things, storing or transporting M3000[®] modules or accessories outside of their original packaging.

⇒ ["1.4 Warranty and Liability" on page 3](#)

7.1 Environmental Conditions

Ambient temperature (IEC 61131-2)

See user manual of the relevant module

Relative air humidity (IEC 61131-2)

See user manual of the relevant module

Contamination level (IEC 60664)

See user manual of the relevant module

Resistance to corrosion (IEC 60068)

See user manual of the relevant module

Air pressure (IEC 61131-2)

≥ 70 kPa (corresponds to an elevation of ≤ 3,000 m (9,843 ft))

Drop height (free fall in the original packaging) (IEC 60068-2-31)

≤ 1 m (3.281 ft)

Environmental conditions of MSC-R-IO are described in

⇒ ["8.2.4.1 Environmental Conditions" on page 26](#)

**Transportation
and Storage:
Environmental Conditions**

8 MSC-R-IO

The MSC-R-IO is used as remote extension module for the Ruggedized Motion Controller (MSC-R), MSC II Motion Controller, MSD Motion Controller or other EtherCAT master modules. It includes an EtherCAT slave interface.

MSC-R-IO

8.1 Performance Characteristics

8.1.1 Interfaces

The MSC-R-IO provides an EtherCAT slave interface for real time communications to a PLC host system.

Interfaces of the MSC-R-IO

8.1.2 I/Os (Inputs/Outputs)

The MSC-R-IO provides the following I/Os:

- 8 Digital isolated outputs, maximum 0.5 A each
- 2x8 Digital isolated inputs
- PT100 temperature measurement input

I/Os (Inputs/Outputs) of the MSC-R-IO

8.2 General Specifications

Dimensions

Overall W × H × D in mm (in):
160 × 105 × 56 (6.25 × 4.1 × 2.2)
⇒ [Figure 4 on page 24](#)

General Specifications of the MSC-R-IO

Weight

Approx. 1.5 kg (3.3 lb)

8.2.1 View of the Module

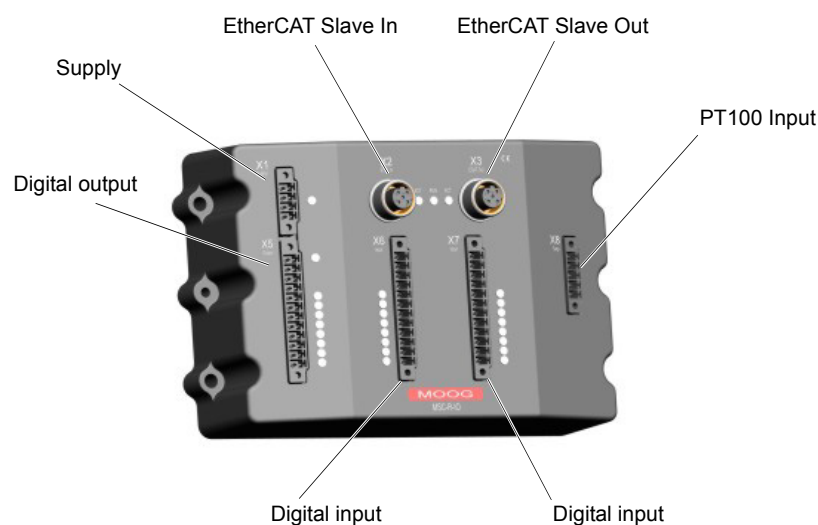

View of the Module

Figure 3: Front view of MSC-R-IO

8.2.2 Dimensions

Width	160 mm (6.30 in)
Height	105 mm (4.13 in)
Depth	58,40 mm (2.30 in)
Required distances of the mounting holes (middle to middle): Width	150 mm (5.90 in)
Required distances of the mounting holes (middle to middle): Height	65 mm (2.56 in)

Dimensions

Table 2: Dimensions of the MSC-R-IO

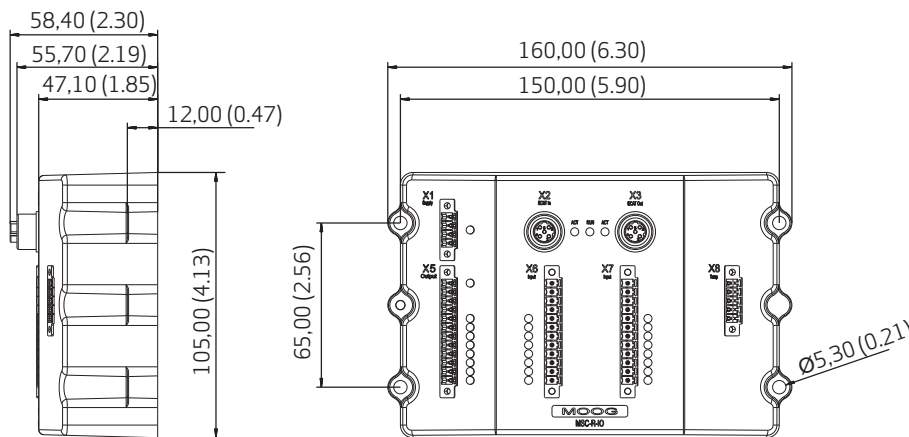

Figure 4: Dimensions of the MSC-R-IO

8.2.3 Mechanical Mounting

8.2.3.1 Arrangement

To attain the best result for EMC-compatible installation the module must be attached to a metal mounting plate and connected to the protective earth conductor.

Additional information about the grounding concept for M3000 modules:

⇒ ["5.1 Grounding Concept" on page 15](#)

Maintain the sufficient distances to ensure:

- Sufficient room for connecting the supply and signal cables
- Sufficient room for mounting or removing the modules

Arrangement of the MSC-R-IO

8.2.3.2 Procedure for Mounting Modules

1. Mark the position for the tapped holes on the backing plate.
2. Cut a tap for each fixing screw in the backing plate.
3. Mount the module on the backing plate.

Mounting Modules

8.2.3.3 Procedure for Removing Modules

1. Loosen the fixing screws
2. Remove the module

Removing Modules

8.2.3.4 MSC-R-IO DIN Rail Mounting Kit

With the MSC-R-IO DIN Rail Mounting Kit the MSC-R-IO can be mounted on a DIN rail. The following figure shows the MSC-R with DIN rail mounting kit as an example.

MSC-R-IO DIN Rail Mounting Kit

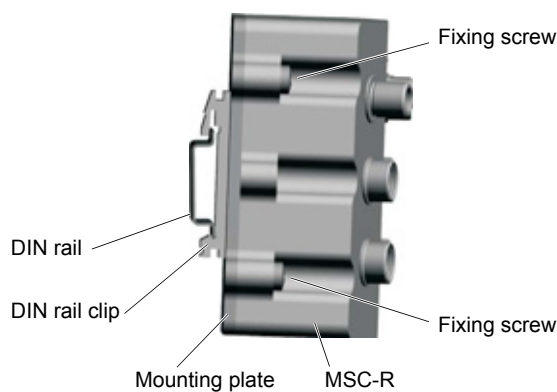

Figure 5: MSC-R DIN Rail Mounting Kit

i The MSC-R-IO DIN Rail Mounting Kit is available from Moog as accessory
⇒ ["9.1 DIN Rail Mounting Kit for the MSC-R-IO" on page 43](#)

8.2.4 Environmental Conditions

WARNING



Maintain under all circumstances the required environmental conditions specified for the M3000[®] automation system or M3000[®] modules.

This ensures fault-free, reliable, and safe operation.

**Environmental
Conditions:
Safety Instructions**

WARNING



It is not permissible to operate the M3000[®] automation system or M3000[®] modules in a potentially explosive environment.

8.2.4.1 Environmental Conditions

Ambient temperature (IEC 61131-2)

For operation (when installed properly): -40 to $+70$ °C (-40 to $+158$ °F)

For transportation and storage

(in the original packaging): -40 to $+80$ °C (-40 to $+176$ °F)

**Environmental
Conditions:
Environmental
Conditions**

Relative air humidity (IEC 61131-2)

For operation: >10 %

For transportation and storage

(in the original packaging): 5 to 95 % non-condensing

Resistance to corrosion (IEC 60068)

- No protection

Operating Elevation (IEC 61131-2)

$\leq 2,000$ m (6,562 ft) above MSL

Air pressure for transportation (IEC 61131-2)

≥ 70 kPa (corresponds to an elevation of $\leq 3,000$ m (9,843 ft))

8.2.4.2 Mechanical Conditions and Requirements

Sinusoidal oscillations (IEC 60068-2-6)

at 1 oct/min sweep rate and three orthogonal axes

10 Hz $\leq f < 60$ Hz: 2.0 mm (0.08 in) continuous amplitude

60 Hz $\leq f < 2,000$ Hz: 30 g continuous constant acceleration

**Environmental
Conditions:
Mechanical Conditions
and Requirements**

Shocks, half-sine wave (IEC 60068-2-27)

Shocks up to 50 g for a duration of 3 ms, 3 shocks in each of the six orthogonal axes (X_{\pm} , Y_{\pm} , Z_{\pm})

Continuous Shocks, half-sine wave (IEC 60068-2-27)

Continuous shocks up to 40 g for a duration of 6 ms, 4,000 shocks in each of the six orthogonal axes (X_{\pm} , Y_{\pm} , Z_{\pm})

Drop height (free fall in the original packaging) (IEC 60068-2-31)

≤ 1 m (3.281 ft)

Protection class (IEC 60529) IP 20

8.2.4.3 Electrical Conditions and Requirements

Power supply

24 V DC

(Safety Extra-Low Voltage (SELV) according to EN 60950-1)

Specified voltage range: 18 to 36 V DC

⇒ "5.2 Power Supply" on page 16

**Environmental
Conditions:
Electrical Conditions
and Requirements**

8.3 Block Diagram

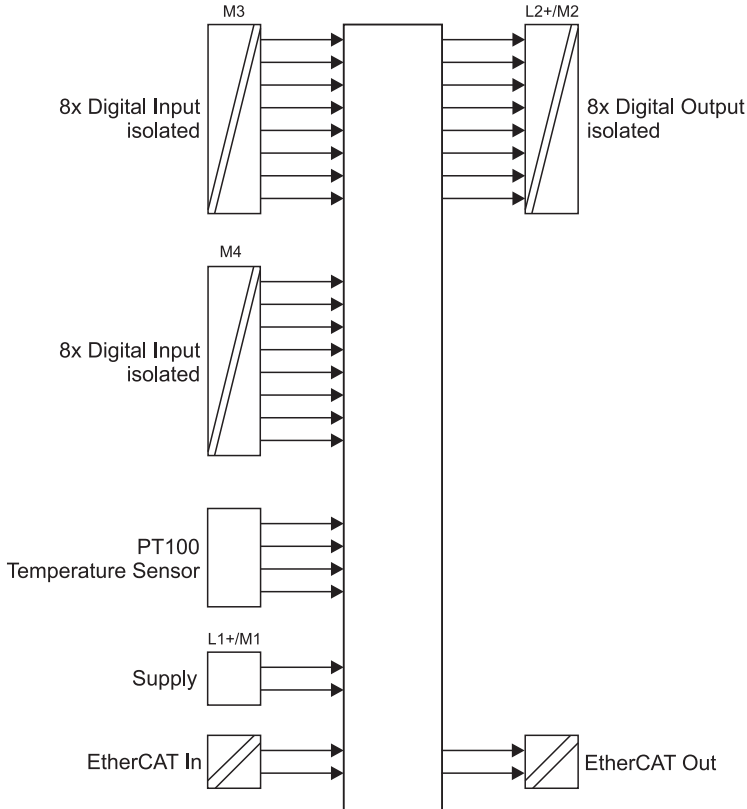

Figure 6: Block Diagram of the MSC-R-IO

8.4 View of the Module and Terminal Assignment

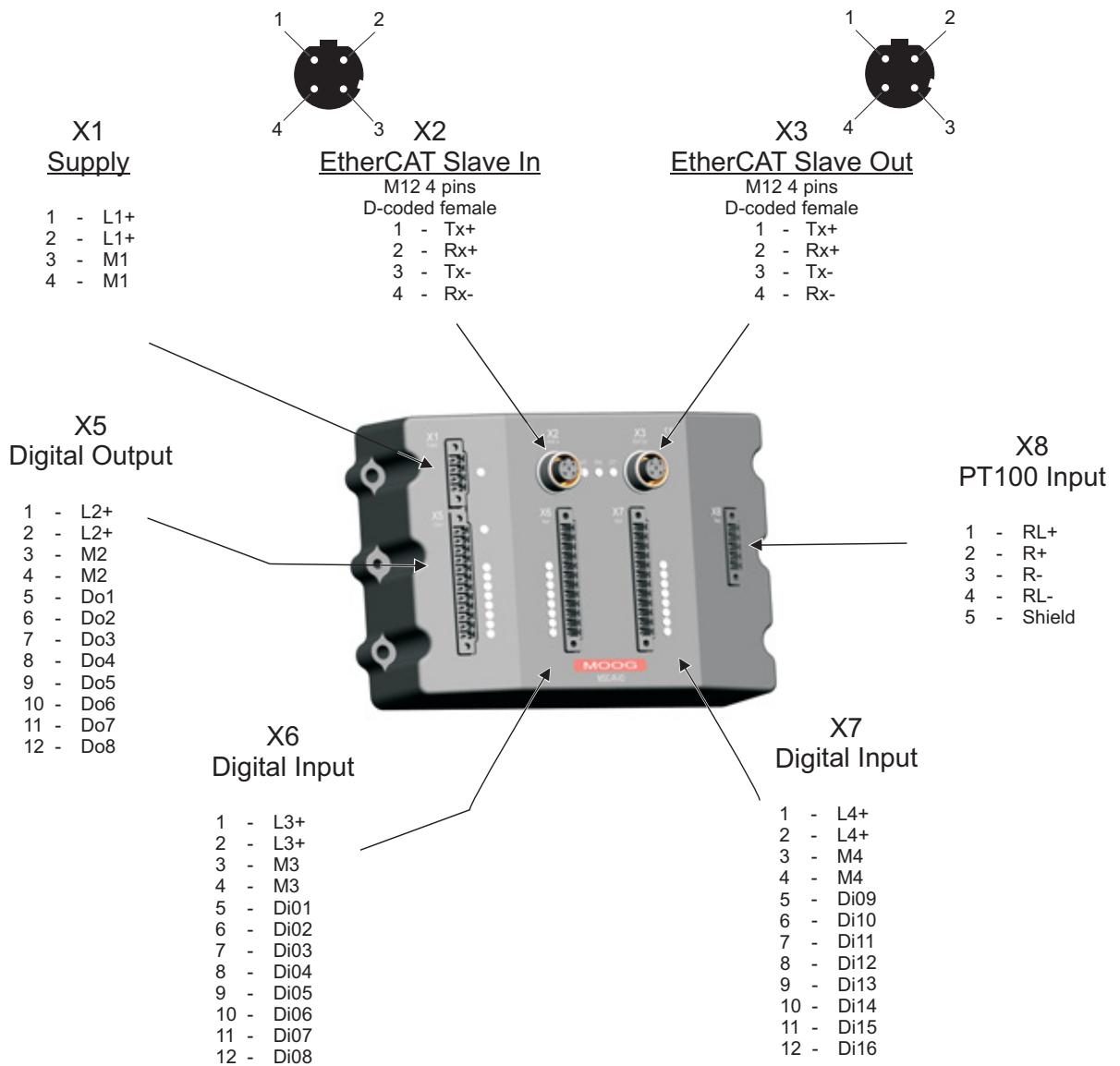

Figure 7: View of the MSC-R-IO and Terminal Assignment

8.4.1 Terminal Assignment

Connector	No.	Assignment	Circuit	
X1 «Supply» 	1	L1+	+24 V power supply for the module	Power Supply
	2	L1+	+24 V power supply for the module	
	3	M1	Ground for the modules' power supply	
	4	M1	Ground for the modules' power supply	
X2  «ECAT Slave In» M12 D-coded 4 pole (socket contacts)	1	Tx+	EtherCAT transmit data+	EtherCAT
	2	Rx+	EtherCAT receive data+	
	3	Tx-	EtherCAT transmit data-	
	4	Rx-	EtherCAT receive data-	
X3  «ECAT Slave Out» M12 D-coded 4 pole (socket contacts)	1	Tx+	EtherCAT transmit data+	EtherCAT
	2	Rx+	EtherCAT receive data+	
	3	Tx-	EtherCAT transmit data-	
	4	Rx-	EtherCAT receive data-	

Table 3: Terminal Assignment of MSC-R-IO's Connectors (Section 1 of 3)

Connector	No.	Assignment	Circuit	
X5 «Output» 	1	L2+	+24 V power supply for digital outputs	Digital Output
	2	L2+	+24 V power supply for digital outputs	
	3	M2	Ground for the digital output power supply	
	4	M2	Ground for the digital output power supply	
	5	Do1	Digital output 1	
	6	Do2	Digital output 2	
	7	Do3	Digital output 3	
	8	Do4	Digital output 4	
	9	Do5	Digital output 5	
	10	Do6	Digital output 6	
	11	Do7	Digital output 7	
	12	Do8	Digital output 8	

Table 3: Terminal Assignment of MSC-R-IO's Connectors (Section 2 of 3)

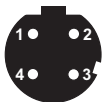
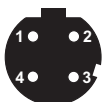

Connector	No.	Assignment	Circuit	
X6 «Input» 	1	L3+	+24 V power supply for digital inputs	Digital Input
	2	L3+	+24 V power supply for digital inputs	
	3	M3	Ground for the digital output power supply	
	4	M3	Ground for the digital output power supply	
	5	Di01	Digital input 1	
	6	Di02	Digital input 2	
	7	Di03	Digital input 3	
	8	Di04	Digital input 4	
	9	Di05	Digital input 5	
	10	Di06	Digital input 6	
	11	Di07	Digital input 7	
	12	Di08	Digital input 8	
X7 «Input» 	1	L4+	+24 V power supply for digital inputs	Digital Input
	2	L4+	+24 V power supply for digital inputs	
	3	M4	Ground for the digital output power supply	
	4	M4	Ground for the digital output power supply	
	5	Di09	Digital input 1	
	6	Di10	Digital input 2	
	7	Di11	Digital input 3	
	8	Di12	Digital input 4	
	9	Di13	Digital input 5	
	10	Di14	Digital input 6	
	11	Di15	Digital input 7	
	12	Di16	Digital input 8	
X8 «Temp» PT100 Input 	1	RL+		PT100 Input
	2	R+		
	3	R-		
	4	RL-		
	5	Shield		

Table 3: Terminal Assignment of MSC-R-IO's Connectors (Section 3 of 3)

8.4.2 LEDs

LED	Display	Explanation	
RUN	EtherCAT status LED	EtherCAT state display	
		LED status	EtherCAT state
		Off	'INIT'
		Blinking	'PRE-OPERATIONAL'
		Single flash	'SAFE-OPERATIONAL'
		Flashes	'INITIALIZATION' or 'BOOTSTRAP'
		On	'OPERATIONAL'
ACT	Communication activity	Blinks when communication is active.	
L1+	Supply voltage OK	Illuminates when the power supply for the MSC-R-IO's internal electronics is OK and the internal voltages are OK.	
L2+	Supply voltage OK	Illuminates when the power supply for the MSC-R-IO's digital outputs is OK.	

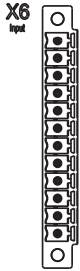
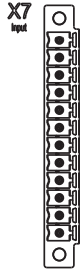
Table 4: LEDs of the MSC-R-IO

8.4.3 EtherCAT Slave Interface

8.4.3.1 Connection of the EtherCAT Slave Interface

The following connector type is required to connect the EtherCAT Slave In (X2) and the EtherCAT Slave Out connector (X3) of the MSC-R-IO

- M12 D-coded connector

EtherCAT Slave Interface

8.4.3.2 Pin assignment of M12 EtherCAT connectors

Pin	Signal	Description
1	Tx+	EtherCAT transmit data +
2	Rx+	EtherCAT receive data +
3	Tx-	EtherCAT transmit data -
4	Rx-	EtherCAT receive data -

Table 5: Pin assignment of M12 EtherCAT connectors

**Pin assignment M12
EtherCAT connectors**

8.4.3.3 Cables and Connectors

Use only cables and connectors that fulfill the requirements of at least category 5 (Cat-5) of EN 50173 or ISO 11801. The maximum cable length between two EtherCAT devices is 100 m.

Cables and Connectors

8.4.3.4 Configuration

The configuration is done in the development environment of the EtherCAT master module. If a Moog Motion Controller is used as EtherCAT master module, then the configuration is done in the PLC configurator of the MACS or MASS development environment:

Configuration

- Append the MSC-R-IO module to the EtherCAT master node in the PLC configurator
- The PDO mapping is fix and not configurable
- EtherCAT slaves do not need any address settings, the addresses are adjusted automatically by the EtherCAT master

8.4.3.5 PDO Mapping List

Receive PDO 1

PDO Mapping List

Index	Name	Description	Data type
3101:1	Digital Output X5	Digital outputs Do1...Do8	UINT8

Table 6: Receive PDO 1

Transmit PDO 1

Index	Name	Description	Data type
3001:1	Digital Input X6	Digital inputs Di01...Di08	UINT8

Table 7: Transmit PDO 1

Transmit PDO 2

Index	Name	Description	Data type
3101:2	Digital Input X7	Digital inputs Di09...Di16	UINT8

Table 8: Transmit PDO 2

Transmit PDO 3

Index	Name	Description	Data type
3101:3	PT100 Input X8	PT100 temperature sensor interface	UINT8

Table 9: Transmit PDO 3

8.4.3.6 Specifications

Supported protocol types to read input data and write output data

Cyclic data transmission via PDO communication. Non-cyclic data via SDO communication is not supported.

Sampling of inputs: digital inputs and temperature sensor

The inputs are sampled with every EtherCAT PDO communication cycle. The sampled data is transmitted with the next Transmit PDO.

Setting of outputs: digital outputs

The outputs are updated after every Receive PDO.

Timeout behavior

A SynchManager watchdog can be configured by the EtherCAT master. If the watchdog expires, then the outputs are set to 0 state. For the Moog Motion Controllers and Machine Controllers the setting of the watchdog is available in the PLC configuration of the MACS and MASS development environment.

Specifications

8.5 Power Supply

DANGER

The 24 V power supply terminals of all M3000[®] modules are protected against reverse polarity. If the polarity of these power supply terminals is reversed, the modules will not work.

**Power Supply of the
MSC-R-IO:
Safety Instructions**

WARNING

M3000[®] modules must be protected from overvoltages and/or reverse energization from the sensor to the module!

There is a danger of:

- Permanent damage by overheating or fire
- Malfunctions

M3000[®] modules must have the correct voltage, polarity, and terminal assignments.

Additional information about the power supply

⇒ ["8.2.4.3 Electrical Conditions and Requirements"](#) on page 26

⇒ ["5.2 Power Supply"](#) on page 16

8.6 Digital I/Os

There are 8 digital outputs and two groups with each 8 inputs.

Basic wiring diagrams:

⇒ [Figure 8 on page 36](#)

⇒ [Figure 9 on page 38](#)

**Digital I/Os of the
MSC-R-IO**

8.6.1 Status Display of Digital I/Os

The status LEDs on the front panel of the MSC-R-IO show the internal operational state of the digital I/Os.

The associated LED of an input will illuminate when it is internally detected that the input is in the 1 state.

The associated LED of an output will illuminate if the output is set to 1 state via the EtherCAT interface and L2+ (+24 V) and M2 (GND) are connected.

Basic wiring diagrams of the digital outputs: ⇒ [Figure 8 on page 36](#)

**Status Display of Digital
I/Os**

8.6.2 Power Supply of the Digital I/Os

DANGER



The 24 V power supply terminals of all M3000[®] modules are protected against reverse polarity. If the polarity of these power supply terminals is reversed, the modules will not work.

**Power Supply of the
Digital I/Os of the
MSC-R-IO:
Safety Instructions**

WARNING



M3000[®] modules must be protected from overvoltages and/or reverse energization from the sensor to the module!

There is a danger of:

- Permanent damage by overheating or fire
- Malfunctions

M3000[®] modules must have the correct voltage, polarity, and terminal assignments.

WARNING

The internal electronics of M3000® modules and attached sensors must be supplied with power from a permanently connected (unswitched) power supply that cannot be individually switched off, without switching off the module's power supply.

If a switched power supply is used, such as when there are intermediate switching devices (emergency stops, manual operators, etc.), the following problems might arise, depending on the state of the power supply for the internal electronics of the module and sensors (⇒ table 1 on page 18):

- Invalid sensor data

The power supply for the digital I/Os of the MSC-R-IO is independent of the power supply for the MSC-R-IO's internal electronics (+24 V / GND):

- L1+ / M1 to supply the module electronics
- L2+/M2 to supply the digital outputs
- M3 as 0 Volt reference for digital inputs Di01 to Di08
- L3+ and L4+ can be used to supply sensors connected to the appropriate digital inputs.
⇒ "8.6.4.1 Basic Wiring Diagram" on page 38
- M4 as 0 Volt reference for digital inputs Di09 to Di16

Power supply characteristics

⇒ "5.2.1 Power Supply Characteristics" on page 16

Connecting sensors to the power supply:

⇒ "5.2.3 Connecting Sensors" on page 18

Connecting the power supply for the internal electronics:

⇒ "5.2.2 Connecting the Power Supply" on page 17

8.6.3 Digital Outputs

The following digital output circuits are available:

- Open emitter outputs, switches to L2+ (+24 V)

Digital Outputs of the MSC-R-IO

Basic Wiring Diagram of a Digital Output of the MSC-R-IO

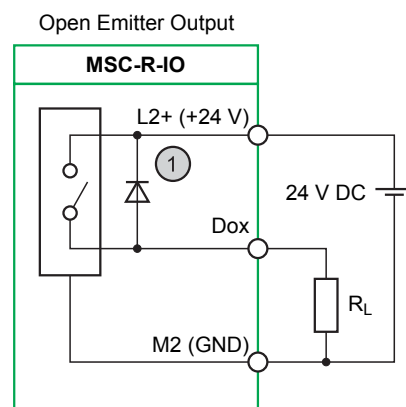

Figure 8: Basic Wiring Diagram of a Digital Output of the MSC-R-IO

- ① Protective circuit with a limiting voltage of 50 V as protection against induced voltage spikes when there are inductive loads.
⇒ "8.6.3.1 Current Limiting and Overload Protection" on page 37

A digital **open emitter output** in the 1 state (conductive) connects the attached load R_L to the power supply terminal L2+ (+24 V).

Open Emitter Output

8.6.3.1 Current Limiting and Overload Protection

All digital outputs are protected by an integrated power limiter and a thermal overload protection device.

In an overload condition, the affected output will be automatically disabled. After the output stage has been finished thermal cooling it returns to normal operation. If the overload is still connected, then the disable will happen again.

A protective circuit with a limiting voltage of 50 V with respect to L2+ (+24 V) for open emitter outputs protects all outputs against induced voltage spikes when there are inductive loads.

Current Limiting and Overload Protection for Digital Outputs of the MSC-R-IO

8.6.3.2 Specifications

Number of digital outputs

8

⇒ "8.6 Digital I/Os" on page 35

Type of outputs

Semiconductor, non-capacitive

Protective circuitry for inductive loads

Limiting voltage of 50 V (typ.) with reference to L2+ (+24 V)

Power dissipation of protection devices when limiting

Max. 0.5 W per output

Max. 1 W per MSC-R-IO

Status display

One status LED per output

⇒ "8.6.1 Status Display of Digital I/Os" on page 35

Power consumption for the internal control circuit (L2+ / M2)

≤ 100 mA

Specifications of MSC-R-IO's Digital Outputs

8.6.3.3 Load Connection

Total load

4 A (8 x 0.5 A), when all 8 outputs are used

Overload protection

Electronic current limiting and thermal overload protection

Max. short-circuit current

< 4 A (L2 fuse)

Reverse energization protection

Digital outputs are protected against reverse energization

Output delay (hardware)

From 0 to 1: max. 100 μs

From 1 to 0: max. 100 μs

Update time

The update time corresponds to the telegram interval time from the EtherCAT master.

Output capacitance

< 20 nF

Rated voltage

+24 V DC

Load Connection of MSC-R-IO's Digital Outputs

Voltage loss (at rated current)

< 2 V

Rated current in 1 state

0.5 A

Leakage current in 0 state

Max. 0.1 mA

Parallel connection of outputs

Not permissible

8.6.3.4 Insulation Resistance

Insulation resistance

Rated voltage: 0–50 V DC

Test voltage for 2,000 m (6,562 ft) operating elevation: 500 V DC

**Insulation Resistance of
MSC-R-IO's Digital
Outputs**

8.6.4 Digital Inputs

The digital inputs are of the type 1 according to IEC 61131-2. They are designed for an input voltage rating of 24 V. The input values (0/1 state) are read synchronized to the EtherCAT telegrams. An open input is interpreted as the 0 state.

**Digital Inputs of the
MSC-R-IO**

8.6.4.1 Basic Wiring Diagram

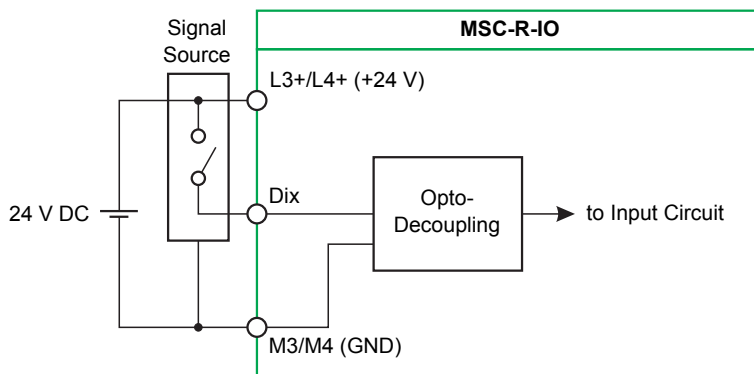

**Basic Wiring Diagram of a
Digital Input of the
MSC-R-IO (Current
Consuming)**

Figure 9: Basic Wiring Diagram of a Digital Input of the MSC-R-IO (Current Consuming)

8.6.4.2 Pulse Detection and Disturbance Suppression

The digital inputs are read synchronized to the EtherCAT telegrams. The sampling time corresponds to the telegram interval time from the EtherCAT master.

For input pulses to be reliably detected, they must be longer than the communication cycle interval of the EtherCAT master.

When defining the minimum pulse duration that can be detected by digital I/Os, the following differentiation is made:

- Pulses that are never detected; pulse duration: $\leq 50 \mu\text{s}$
- Pulses that can be detected (if the system reads the input when the pulse appears); pulse duration: $> 50 \mu\text{s}$
- Pulses that are always detected; pulse duration: $>$ the communication cycle interval of the EtherCAT master

The user may implement multiple sampling in the application program in order to suppress disturbance impulses. In doing so, the user must consider the tradeoff between the desired level of disturbance suppression and the required reaction time of the system.

8.6.4.3 Specifications

Number of the digital inputs

16 inputs in 2 groups
⇒ "8.6 Digital I/Os" on page 35

Type

Type 1 according to IEC 61131-2, current consuming

Wire lengths

In the control cabinet: The voltage drop must be taken into consideration when choosing the wire cross section; there are no other practical limitations.

Field wiring: All relevant national regulations as well as the requirements of IEC 61131-3 must be fulfilled.

Rated voltage L3+/L4+ (+24 V)

24 V DC (safety extra-low voltage SELV according to EN 60950-1)

Reverse polarity protection

Digital inputs are protected against reverse polarity

Potential isolation

Achieved with optocouplers

Status display

One status LED per input
⇒ "8.6.1 Status Display of Digital I/Os" on page 35

Alarms

Can be implemented in the application program

Input delay (hardware)

From 0 to 1: max. 100 μs
From 1 to 0: max. 100 μs

Sampling time

The sampling time corresponds to the telegram interval time from the EtherCAT master.

⇒ "8.6.4.2 Pulse Detection and Disturbance Suppression" on page 39

Input capacitance

Max. 10 nF

Pulse Detection and Disturbance Suppression of MSC-R-IO's Digital Inputs

Specifications of MSC-R-IO's Digital Inputs

Power consumption for the internal control circuit (L3+ / M3 and L4+ / M4)

0 mA (L3+ and L4+ are not used for internal electronics, they may be used for supply of external sensors)

Reverse energization protection

Yes

Insulation resistance

Rated voltage: 0–50 V DC

Test voltage for 2,000 m (6,562 ft) operating elevation: 500 V DC

8.6.4.4 U/I Working Ranges

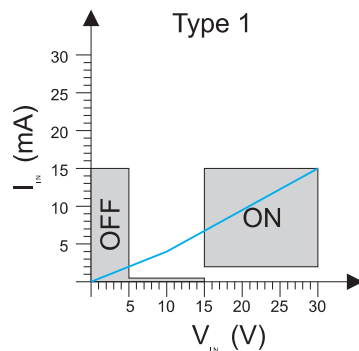

U/I Working Ranges of MSC-R-IO's Digital Inputs (Current Consuming)

Figure 10: U/I Working Ranges of MSC-R-IO's Digital Inputs (Current Consuming)

Input voltage (DC) of the external power supply L2+ (+24 V)	rated voltage	$U_e = 24 \text{ V}$
	upper limit	$U_{e \text{ max}} = 36 \text{ V}$
	lower limit	$U_{e \text{ min}} = 18 \text{ V}$
Limits for the 1 state	upper limit	$U_{H \text{ max}} = 30 \text{ V}$ $I_{H \text{ max}} = 15 \text{ mA}$
	lower limit	$U_{H \text{ min}} = 15 \text{ V}$ $I_{H \text{ min}} = 2 \text{ mA}$
Limits for the 0 state	upper limit	$U_{L \text{ max}} = 15/5 \text{ V}$ $I_{L \text{ max}} = 0.5/15 \text{ mA}$
	lower limit	$U_{L \text{ min}} = -3 \text{ V}$ $I_{L \text{ min}} = \text{ND}$

Table 10: U/I Working Ranges of MSC-R-IO's Digital Inputs (Current Consuming)

8.7 Temperature Sensor Input

Sensor type

1 channel PT100

Temperature Sensor Input

Temperature range

8 bit value representing -50 to $+205 \text{ }^\circ\text{C}$ (-58 to $+401 \text{ }^\circ\text{F}$)

Resolution

$1 \text{ }^\circ\text{C}$ / per digit

Update rate (time between two temperature measurements)

$< 1 \text{ s}$

Wiring configuration

Four-wire configuration

Tolerance

$\pm 3 \text{ }^\circ\text{C}$

8.7.1 PT Connection Diagram

The PT100 interface is designed for 4 wire connection.

PT Connection Diagram

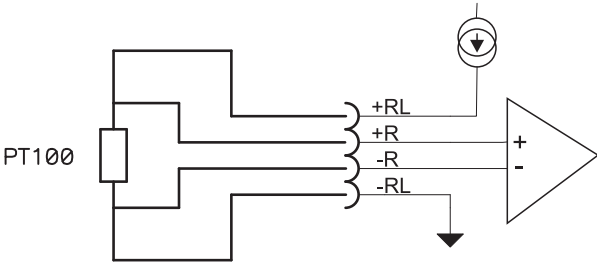

Figure 11: PT connection diagram

8.8 EtherCAT Interface

The MSC-R-IO provides an EtherCAT slave interface at «X3» and «X4».

The configuration of the network nodes is done in the PLC Configuration of the development environment MACS or MASS (or any other EtherCAT master configurator, if no Moog Motion Controller or Machine Controller is used as EtherCAT master).

EtherCAT interface of the MSC-R-IO

WARNING



Do not connect EtherCAT to any other Ethernet networks. The high rate of broadcast telegrams which are transmitted by EtherCAT will prevent other devices like computers and servers on the network from transmitting data.

There is a danger of

- Network overload/breakdown
- Malfunction of connected devices
- Data loss at connected devices

It is strongly recommended to use cables of a special color only for EtherCAT connections.

8.9 Nameplate

Nameplate of the MSC-R-IO

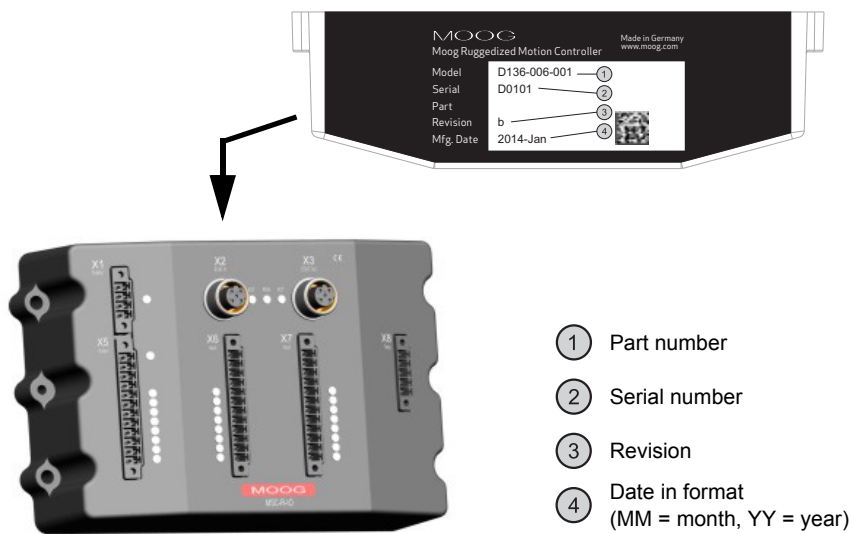

Figure 12: Position of the Nameplate on the MSC-R-IO

9 Product Range

i The following chapter describes only a small part of Moog's extensive product range. In addition to the many different M3000® modules, Moog's current product range includes a large variety of accessories.

9.1 DIN Rail Mounting Kit for the MSC-R-IO

Item Designation	Remarks	Part Number
DIN rail mounting kit for the MSC-R or MSC-R-IO	Accessory kit for mounting the MSC-R or MSC-R-IO on a DIN rail, including: DIN rail clip, mounting plate and screws. ⇒ "8.2.3.4 MSC-R-IO DIN Rail Mounting Kit" on page 25	CA94286-001

Product Range – DIN Rail Mounting Kit for the MSC-R-IO

Table 11: Product Range – DIN Rail Mounting Kit for the MSC-R-IO

9.2 Plug-In Terminal Strips

Terminal strips for MSC-R-IO

Number of required connectors	Pole count	Connector name on module	Maximum conductor cross-section	Part number
1	4	X1	0.5 mm ² (20 AWG)	Spring power clamp version: CA96981-004 (Phoenix Contact: FMC 1,5/4-STF-3,5)
3	12	X5, X6, X7	0.5 mm ² (20 AWG)	Spring power clamp version: CA96981-012 (Phoenix Contact: FMC 1,5/12-STF-3,5)
1	5	X8	0.5 mm ² (20 AWG)	Spring power clamp version: CA96981-005 (Phoenix Contact: FMC 1,5/5-STF-3,5)

**Product Range:
Plug-In Terminal Strips
for DIN Rail Modules**

Table 12: Product Range – Plug-In Terminal Strips

10 Appendix

10.1 Typographical Conventions

DANGER



Identifies safety instructions that are intended to warn of an immediate and impending danger to life and limb or major property damage.

Failure to observe these safety instructions will lead inevitably to death, serious personal injury (disablement) or major property damage!

Typographical Conventions

WARNING



Identifies safety instructions that are intended to warn of potential danger to life and limb or the potential for major property damage.

Failure to observe these safety instructions might lead to death, serious personal injury (disablement) or major property damage!

CAUTION



Identifies safety instructions that are intended to warn of slight personal injury or minor property damage.

Failure to observe these safety instructions might lead to slight personal injury or minor property damage.

• / –

Identifies listings



Identifies references to another chapter, another page, table or figure in this manual

blue text

Identifies a hyperlink within the PDF file



Identifies important information

1., 2., ...

Identifies steps in a procedure that should be performed in consecutive order

①, ②, ...

Identifies items in a figure that are explained separately

«WCAN»

Identifies terminals or connectors (such as: «WCAN») and light emitting diodes (such as: «I/O1») of an M3000® module

'Frequency'

Identifies parameters of the MACS development environment (such as: 'Frequency') and outputs of M3000® modules (such as: 'Outputs Enabled')

10.2 Abbreviations

Abbreviation	Explanation
AC	Alternating Current
ADC	Analog to Digital Converter
AWG	American Wire Gauge (standardized wire gauge system for diameters of wires)
CAL	CAN Application Layer according to CiA DS 201–207
CAN	Controller Area Network
CFC	Continuous Function Chart (random-graphics functional chart editor; programming language for creating PLC programs)
CiA	CAN in Automation e. V. (international organization of manufacturers and users for CAN users; http://www.can-cia.org)
CLK	Clock
CPU	Central Processing Unit
DAC	Digital to Analog Converter
DC	Direct Current
DGND	Digital Ground (Ground for the digital I/Os' power supply of the MSC-R-IO)
DIN	Deutsches Institut für Normung e. V. (German Institute for Standardization; http://www.din.de)
DIS	Draft International Standard (preliminary standard)
DS	Draft Standard (draft standard)
E-bus	Extension bus of DIN rail modules
EEPROM	Electrically Erasable Programmable Read Only Memory
EIA	Electronic Industries Alliance (http://www.eia.org)
EMC	Electromagnetic Compatibility
EN	Europa-Norm (European Standard)
EPROM	Erasable Programmable Read Only Memory
ESD	Electrostatic Discharge
EtherCAT	Ethernet-based industrial real-time communication system
FBD	Function Block Diagram (programming language for creating PLC programs)
F-Bus	Fieldbus, an industrial communication system such as Profibus
Flash EEPROM	High speed EEPROM
FPGA	Field Programmable Gate Array (programmable logic component)
GUI	Graphical User Interface
HF	High Frequency
HMI	Human Machine Interface (MACS HMI: Visualization package which can be run without MACS)
ID	Identifier
IEC	International Electrotechnical Commission (http://www.iec.ch)
IEEE	Institute of Electrical and Electronics Engineers, Inc. (http://www.ieee.org)
IL	Instruction List (programming language for creating PLC programs)
I/O	Input/Output
IP	International Protection (protection type)
IP	Internet Protocol
ISO	International Organization for Standardizing (http://www.iso.org)
LAN	Local Area Network
LCD	Liquid Crystal Display
LD	Ladder Diagram (programming language for creating PLC programs)

Table 13: Abbreviations

Table 13: Abbreviations (Section 1 of 3)

Abbreviation	Explanation
LED	Light Emitting Diode
LSB	Least Significant Bit
M3000®	Moog Automation System
MACS	Moog Axis Control Software (Development environment according to IEC 61131 for solving complex control tasks)
Mbit/s	Megabits per second
MSB	Most Significant Bit
MSC I	Moog Servo Controller I (Multi axis Moog Motion Controller for DIN top-hat rail mounting)
MSC II	Moog Servo Controller II (Multi axis Moog Motion Controller for DIN top-hat rail mounting)
MSC-R	Moog Servo Controller - Ruggedized (Control module in IP67 rugged design)
MSC-R-IO	Moog Servo Controller - Ruggedized I/O module (Control module in IP20 rugged design)
MSD	Modular Multi-Axis Programmable Motion Control Servo Drive
MSD Motion Controller	Multi-Axis High Performance Motion Controller
MSD Servo Drive	A modular family of electrical servo drives to run permanent magnet synchronous, linear and asynchronous motors
MSL	Mean Sea Level
NC	Not Connected
ND	Not Defined
PC	Personal Computer
PE	Protective Earth
PLC	Programmable Logic Control(ler)
Q-Connector	40 pole lateral connector of DIN rail modules
R-Modules	Remote modules such as RDIO and RDISP (connection via CAN bus)
RAM	Random Access Memory (read and write memory that loses its contents when power is removed)
RDIO	Remote module with digital I/Os and CANopen interface (connection via CAN bus)
RDISP	Remote Display (display and operating terminal with TIA/EIA 232 and CANopen interface (connection via CAN bus))
REF	Reference voltage
RISC	Reduced Instruction Set Computer
RT-ETH	Real Time Ethernet Interface
Rx	Receive Data
SELV	Safety Extra-Low Voltage (according to EN 60950-1)
SFC	Sequential Function Chart (programming language for creating PLC programs)
SHLD	Shield
SIO	Serial I/O (serial interface of the MSC II)
SSI	Synchronous Serial Interface (digital interface for transferring positioning information, like with position transducers)
ST	Structured Text (programming language for creating PLC programs)
TIA	Telecommunications Industry Association (http://www.tiaonline.org)
TPU	Time Processing Unit (programmable microprocessor that processes time functions independently of the CPU)
TÜV	Technischer Überwachungsverein (German agency performing technical inspections)

Table 13: Abbreviations

Table 13: Abbreviations (Section 2 of 3)

Abbreviation	Explanation
Tx	Transmit Data
USB	Universal Serial Bus
V DC	Volt Direct Current (unit of direct voltage)
VDE	Verband der Elektrotechnik Elektronik Informationstechnik (Association for Electrical, Electronic & Information Technologies; http://www.vde.de)
VDMA	Verband Deutscher Maschinen- und Anlagenbau e. V. (Federation of Engineering Industries; http://www.vdma.org)
WCAN	WideCAN: Naming convention to distinguish between the two CAN controller interfaces
WF	Wire Fault

Table 13: Abbreviations (Section 3 of 3)

Table 13: Abbreviations

10.3 Quoted Standards

10.3.1 CiA DS

CiA DS 201–207

CiA Draft Standard: CAN Application Layer (CAL)

Quoted Standards: CiA DS

CiA DS 301

CiA Draft Standard: CANopen Communication Profile for Industrial Systems – Based on CAL

CiA DS 401

CiA Draft Standard: CANopen Device Profile for Generic I/O Modules

10.3.2 DIN

DIN 41652

Rack and Panel Connectors, Trapezoidal, Round Contacts 1 mm

Quoted Standards: DIN

10.3.3 EN

EN ISO 9227

Corrosion tests in artificial atmospheres - Salt spray tests

Quoted Standards: EN

EN 60715

Dimensions of Low Voltage Switchgear and Controlgear – Standardized Mounting on Rails for Mechanical Support of Electrical Devices in Switchgear and Controlgear Installations

EN 60950-1

Information Technology Equipment – Safety – Part 1: General Requirements

EN 61000-6-1

Electromagnetic Compatibility (EMC) – Part 6-1: Generic Standards; Immunity for Residential, Commercial and Light-Industrial Environments

EN 61000-6-2

Electromagnetic Compatibility (EMC) – Part 6-2: Generic Standards: Immunity for Industrial Environments

EN 61000-6-3

Electromagnetic Compatibility (EMC) – Part 6-3: Generic Standards; Emission Standard for Residential, Commercial and Light-Industrial Environments

EN 61000-6-4

Electromagnetic Compatibility (EMC) – Part 6-4: Generic Standards; Emission Standard for Industrial Environments

EN 60204

Safety of Machinery – Electrical Equipment of Machines

10.3.4 IEC**IEC 60068**

Environmental Testing

Quoted Standards: IEC**IEC 60068-2-6**

Environmental Testing – Part 2: Tests; Test Fc: Vibration (Sinusoidal)

IEC 60068-2-27

Environmental Testing – Part 2-27: Tests; Test Ea and Guidance: Shock

IEC 60068-2-31

Environmental Testing – Part 2: Tests; Test Ec: Drop and Topple, Primarily for Equipment-Type Specimens

IEC 60364-4-44

Electrical Installations of Buildings – Part 4-44: Protection for Safety – Protection against Voltage Disturbances and Electromagnetic Disturbances

IEC 60068-2-52

Environmental testing - Part 2: Tests, Test Kb: Salt mist, cyclic (sodium chloride solution)

IEC 60529

Degrees of Protection Provided by Enclosures (IP Code)

IEC 60664

Insulation Coordination for Equipment within Low Voltage Systems

IEC 60801-2

Electromagnetic Compatibility for Industrial-Process Measurement and Control Equipment – Part 2: Electrostatic Discharge Immunity Requirements

IEC 61131

Programmable Controllers

IEC 61131-1

Programmable Controllers – Part 1: General Information

IEC 61131-2

Programmable Controllers – Part 2: Equipment Requirements and Tests

IEC 61131-3

Programmable Controllers – Part 3: Programming Languages

IEC 61131-4

Programmable Controllers – Part 1: User Guidelines

10.3.5 ISO/DIS**ISO/DIS 11898**

Road Vehicles – Controller Area Network (CAN)

**Quoted Standards:
ISO/DIS**

10.3.6 TIA/EIA

TIA/EIA 232 (previously RS 232)

Interface Between Data Terminal Equipment and Data Circuit – Terminating Equipment Employing Serial Binary Data Interchange

Quoted Standards:
TIA/EIA

TIA/EIA 422 (previously RS 422)

Electrical Characteristics of Balanced Voltage Digital Interface Circuits

TIA/EIA 485 (previously RS 485)

Electrical Characteristics of Generators and Receivers for Use in Balanced Digital Multipoint Systems

11 Index

A

Abbreviations used • 45

Air humidity, relative

- permissible for operating the MSC-R-IO • 26
- permissible for transportation and storage
 - M3000® modules • 22
 - MSC-R-IO • 26

Air pressure, permissible

- for transportation and storage
 - M3000® modules • 22
 - MSC-R-IO • 26

Ambient temperature

- permissible for operating the MSC-R-IO • 26
- permissible for transportation and storage
 - M3000® modules • 22
 - MSC-R-IO • 26

Arrangement of the MSC-R-IO • 25

B

Basic wiring diagram

- digital input of the MSC-R-IO • 38
- digital output of the MSC-R-IO • 36

Block diagrams

- Block Diagram of the MSC-R-IO • 27

C

CE labeling of the M3000® modules • A, 4

Cleaning

- safety instructions • 9, 20

Contamination level

- M3000® modules • 22

Copying prohibition for this manual • A

Copyright

- for software that is installed on M3000® products • 5
- for this manual • A

Current, maximum admissible current for the power supply terminals of the MSC-R-IO • 18

D

Digital

- terminal assignment • 30

Digital input of the MSC-R-IO, digital

- terminal assignment • 31

Digital outputs of the MSC-R-IO • 30

Dimensions

- MSC-R-IO • 23, 24

DIN rail mounting kit for the MSC-R-IO • 25

- part numbers • 43

Disposing M3000® modules • 4

Disturbance suppression of digital inputs • 39

Drop height, permissible

- M3000® modules • 22
- MSC-R-IO • 26

Duplication prohibition for this manual • A

E

Electromagnetic Compatibility • 4

EMC • 4

EMC-compatible installation • 25

Environmental conditions

- for operating M3000® modules • 11
- for operating the MSC-R-IO • 26
 - climatic conditions • 26
 - electrical conditions and requirements • 26
 - mechanical conditions and requirements • 26
- for transporting and storing M3000® modules • 22
- limitations of using M3000® modules • 12
- requirements from IEC 61131-2 • 11
- resistance to corrosion • 26
- safety instructions • 7, 11, 26

Environmental protection

- disposing M3000® modules • 4
- no harmful emissions from M3000® modules (when used properly) • 4

ESD

- safety instructions • 7

EtherCAT interface

- MSC-R-IO • 42

Ethernet

- Ethernet interface of the MSC-R-IO
 - terminal assignment • 29

Ethernet LAN connector • 29

F

Figures, list of • v

Front panel

- MSC-R-IO • 28

Front view

- MSC-R-IO • 23

G

Grounding

- grounding concept • 15
- signal grounding of the MSC-R-IO • 15

I

- I/Os of the MSC-R-IO, digital** • 23, 35–40
 - digital inputs • 38–40
 - basic wiring diagram • 38
 - disturbance suppression • 39
 - insulation resistance • 40
 - pulse detection • 39
 - specifications • 39
 - U/I working ranges • 40
 - digital outputs • 36–38
 - basic wiring diagram • 36
 - insulation resistance • 38
 - load connection • 37
 - open collector outputs • 36
 - open emitter outputs • 36
 - overload protection • 37
 - specifications • 37
- LEDs of the MSC-R-IO for displaying the operational state • 35
- power supply • 35
- Insensitivity to corrosion**
 - M3000® modules • 22
 - MSC-R-IO • 26
- Installation** • 14
 - safety instructions • 8, 13, 17, 18
- Insulation resistance**
 - digital inputs of the MSC-R-IO • 38
 - digital outputs of the MSC-R-IO • 40
- Interfaces of the MSC-R-IO** • 23
 - terminal assignment • 28–31

L

- LAN**
 - LAN interface of the MSC-R-IO
 - terminal assignment of the «X2» connector • 29
- LEDs of the MSC-R-IO** • 32
 - display the operational state of the digital I/Os • 35
- Liability**
 - exclusion of liability • 3
 - exclusion of liability for this manual • 1
- List of figures** • v
- List of tables** • iv
- Load connection of digital outputs** • 37

M

- Maintenance** • 21
 - safety instructions • 9, 20
- Maximum admissible current for the power supply terminals of the MSC-R-IO** • 18
- Moog Global Support** • 21
- Mounting**
 - MSC-R-IO • 25
 - MSC-R-IO DIN rail mounting kit • 25
- MSC-R DIN rail mounting kit** • 25
- MSC-R-IO** • 23–42
 - dimensions • 23, 24
 - environmental conditions for operation • 26
 - climatic conditions • 26
 - electrical conditions and requirements • 26
 - mechanical conditions and requirements • 26
 - front panel • 28
 - view of the module • 23

N

- Nameplate**
 - MSC-R-IO • 42

O

- Operating elevation** • 26
- Original packaging is to be retained!** • 3
- Oscillations, permissible for MSC-R-IO** • 26
- Overload protection of digital outputs** • 37

P

- Packaging**
 - Original packaging is to be retained! • 3
- Part numbers**
 - DIN rail mounting kit for the MSC-R-IO • 43
 - plug-in terminal strips for DIN rail modules • 43
- Personnel, selection and qualification**
 - only qualified users may work with and on M3000®! • 2
- Place of storage for manuals** • 1
- Plug-in terminal strips for DIN rail modules**
 - connection methods • 19
 - part numbers • 43
 - spring loaded terminals • 19
- Power supply** • 16–18
 - characteristics • 16
 - connecting M3000® modules • 18
 - digital I/Os of the MSC-R-IO • 35
 - maximum admissible current • 18
 - MSC-R-IO • 26, 34
 - rated voltage • 16
 - safety extra-low voltage SELV • 17
 - sensors • 18
- Power supply connector** • 29
- Power supply of the MSC-R-IO**
 - terminal assignment of the «X1» connector • 29
- Product range** • 43
- Project planning** • 14
 - safety instructions • 8, 17, 18
- Proper use** • 2
 - safety related systems • 2
- Protection class of the MSC-R-IO** • 26
- PT100 Input** • 31
- Pulse detection of digital inputs** • 39

R

- Rated voltage of the power supply** • 16
- Release date of this manual** • 1
- Removing**
 - MSC-R-IO • 25
- Repair** • 21
 - Moog Global Support • 21
 - safety instructions • 9, 20
- Reproduction prohibition for this manual** • A
- Reservation of changes for this manual** • A, 1
- Resistance to corrosion**
 - MSC-R-IO • 26
- Retain the original packaging!** • 3
- Reverse energization is to be avoided!** • 17, 18, 35

S**Safety extra-low voltage SELV** • 17**Safety instructions**

- cleaning • 9, 20
- environmental conditions • 7, 11, 26
- ESD • 7
- installation • 8, 13, 17, 18
- maintenance • 9, 20
- mounting
 - MSC-R-IO • 13
- project planning • 8, 17, 18
- removing
 - MSC-R-IO • 13
- repair • 9, 20
- safety related systems • 2, 6
- service • 9, 20
- shutdown • 9, 20
- storing M3000® modules • 10, 22
- transporting M3000® modules • 10, 22
- typographical conventions • 6, 44

Safety related systems • 2

- safety instructions • 2, 6

Sensors

- connecting to the power supply • 18
- connecting with digital I/O cable • 19

Service

- safety instructions • 9, 20

Shock, permissible for MSC-R-IO • 26**Shutdown**

- safety instructions • 9, 20

Signal cables

- connection with digital I/O cable • 19

Software

- copyright • 5

Standards

- overview of quoted standards • 47–49

Storing M3000® modules

- environmental conditions • 22
 - air pressure, permissible • 22
 - ambient temperature, permissible • 22
 - contamination level • 22
 - insensitivity to corrosion • 22
 - relative air humidity, permissible • 22
- safety instructions • 10, 22

Storing manuals

- place of storage • 1

T**Table of Contents** • i**Tables, list of** • iv**Terminal assignment**

- MSC-R-IO • 28–31

Trademarks • 5**Transporting M3000® modules**

- environmental conditions • 22
 - air pressure, permissible • 22
 - ambient temperature, permissible • 22
 - contamination level • 22
 - insensitivity to corrosion • 22
 - relative air humidity, permissible • 22
- safety instructions • 10, 22

Typographical conventions • 44**U****U/I working ranges of digital inputs** • 40**User manual M3000® and MSC-R**

- version number • 1

User manual M3000® and MSC-R-IO

- copyright • A
- date of release • 1
- duplication prohibition • A
- exclusion of liability • 1
- place of storage • 1
- reproduction prohibition • A
- reservation of changes • A, 1

V**Version number of this manual** • 1**W****Warranty**

- exclusion of warranty • 3

Weight of the MSC-R-IO • 23

TAKE A CLOSER LOOK.

Moog designs a range of products that complement the performance of those featured in this user manual. Visit our Web site for more information and the Moog facility nearest you.

Argentina
+54 11 4326 5916
info.argentina@moog.com

Australia
+61 3 9561 6044
info.australia@moog.com

Brazil
+55 11 3572 0400
info.brazil@moog.com

Canada
+1 716 652 2000
info.canada@moog.com

China
+86 21 2893 1600
info.china@moog.com

Finland
+358 10 422 1840
info.finland@moog.com

France
+33 1 4560 7000
info.france@moog.com

Germany
+49 7031 622 0
info.germany@moog.com

Hong Kong
+852 2 635 3200
info.hongkong@moog.com

India
+91 80 4057 6666
info.india@moog.com

Ireland
+353 21 451 9000
info.ireland@moog.com

Italy
+39 0332 421 111
info.italy@moog.com

Japan
+81 46 355 3767
info.japan@moog.com

Korea
+82 31 764 6711
info.korea@moog.com

Luxembourg
+352 40 46 401
info.luxembourg@moog.com

The Netherlands
+31 252 462 000
info.thenetherlands@moog.com

Norway
+47 6494 1948
info.norway@moog.com

Russia
+7 8 31 713 1811
info.russia@moog.com

Singapore
+65 677 36238
info.singapore@moog.com

South Africa
+27 12 653 6768
info.southafrica@moog.com

Spain
+34 902 133 240
info.spain@moog.com

Sweden
+46 31 680 060
info.sweden@moog.com

Switzerland
+41 71 394 5010
info.switzerland@moog.com

Turkey
+90 216 663 6020
info.turkey@moog.com

United Kingdom
+44 (0) 1684 858000
info.uk@moog.com

USA
+1 716 652 2000
info.usa@moog.com

www.moog.com/industrial

Moog is registered trademark of Moog Inc. and its subsidiaries. All trademarks as indicated herein are the property of Moog Inc. and its subsidiaries.
© 2014 Moog GmbH. All rights reserved. All changes reserved.

Moog Literature Name
User Manual M3000* and MSC-R-10
Rev. A, May 2014, CDS40991-001